



510x510 HERKULES X-CNC

54x1,6



510



510*



510x530

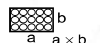

510x460



3x400V 50 Hz



7,5



15-80



6060x54x1,6



6380

Lmin
3360

Lmax
3720

B
2400

Hmin
2100

Hmax
2500

V
810



510x510
HERKULES X-CNC

OPTION
STANDARD

500-F

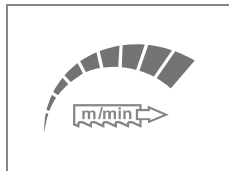

LED

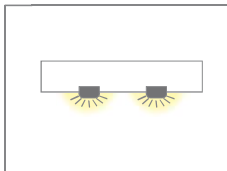

510-ECK

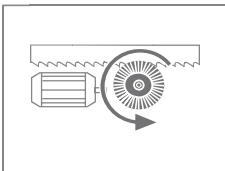

510-NPH

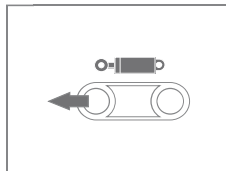

510-HPV

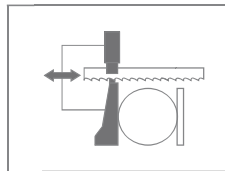

510-DPP

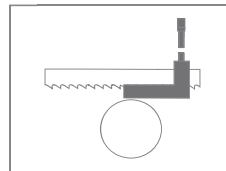

510-RTS-A

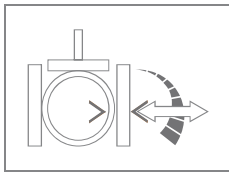

PEGAS-ARP

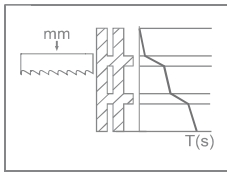

PEGAS-ASR

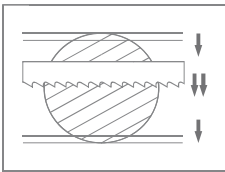

PEGAS-RZP

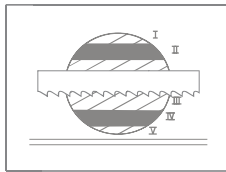

510-CMU-1

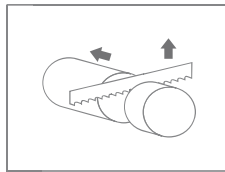

510-OCF

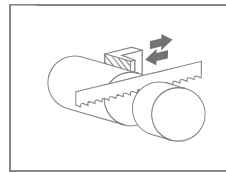

500-HP-A

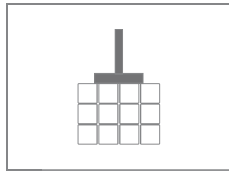

510-ATB

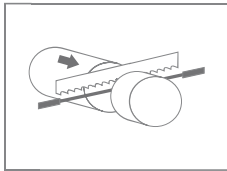

MINI LUBE 54

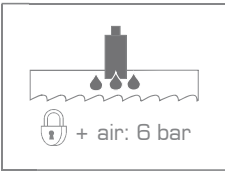

510-OCS

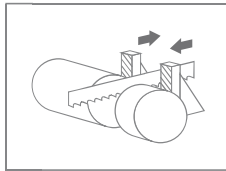

510-KKR

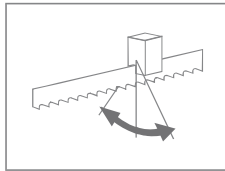

LASER LINE

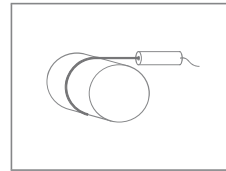

BLUEBOX

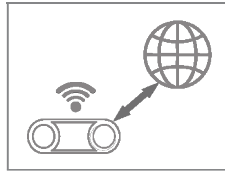

PCP

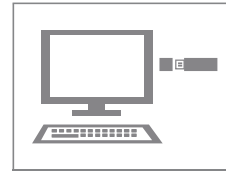

500-RDP 1000/620
+RBR

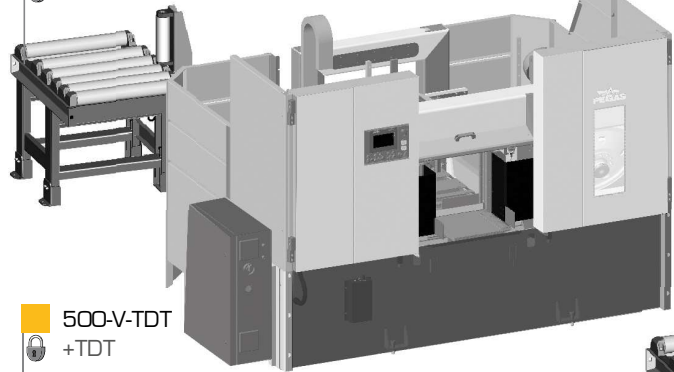

510-VTT

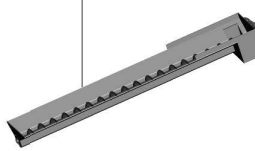

500-V-TDT
+TDT



500-RDZ 1000/620
+RBR



500-TDT-RBRS
+TDT-RBR

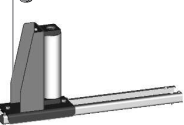

500-TDT-RBR



VZM-620

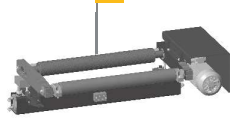

500-RDH



510-TDT 1000/570

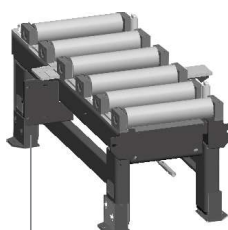

510-TDT 2000/570



500-RDT 2000/620



500-RDT 1000/620

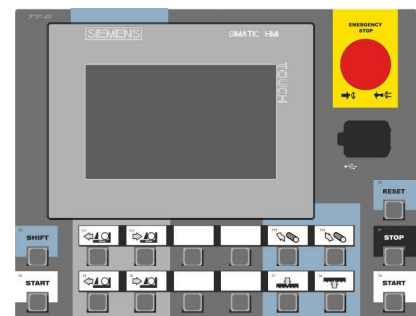

CONTROL PANEL: SIEMENS (X-CNC)

510x510 HERKULES X-CNC

- výrobce si vyhrazuje právo provádět změny
technických údajů, technické údaje odpovídají 1.1.2020
/ producer has the right to make changes of technical data,
technical data are valid on 1.1.2020

- pila na fotografii není vždy v základním provedení,
uvedené rozměry odpovídají stroji v základním provedení
/ the machine in the picture is not always in the basic version,
mentioned diameters are for machine in basic version

* doporučená hodnota. Při překročení doporučeného
maximálního průměru není možné garantovat výkon
pilového pásu!
/ recommended value. The blade performance cannot
be guaranteed
when the recommended diameter is exceeded!

☒ - řezání svazků bez horního přitlaku
/ cutting of the bundle without top clamping



PEGAS - GONDA s.r.o.
Čs.armády 322, 684 01 Slavkov u Brna,
CZECH REPUBLIC

www.pegas-gonda.cz
00420-544 221 125 (126) | pegas@gonda.cz